

Data Sheet

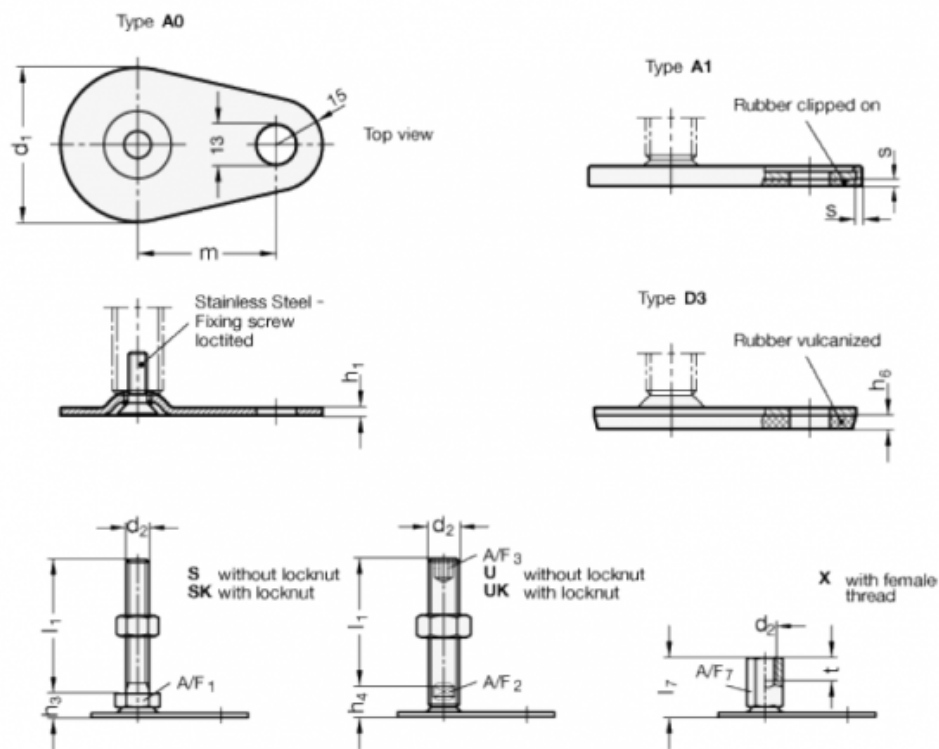

Article number: 204260M12125A1SK
 Description: E+G levelling foot
 GN 42-60-M12-125-A1-SK
 Note: SK With nut, External hexagon at the bottom

Measures



A/F1 = 17	s = 2
d1 = 60	
d2 = M12	
h1 = 2.5	
h3 = 11	
h6 =	
l1 = 125	
m = 50	